

COLOR:

FINISH: POLISHED

SUEDE*
CHECK AVAILABILITY

DUSJBUNN - DOPPIO

MAX SIZE: A: 1200 X B: 3000 MM

WANTED DELIVERY WEEK

A: DYBDE

B) LENGDE:

REFEANSENR:

Max 1200 X 3000 mm / If any area of the shower tray exceed 1500 mm it will be a drying area without slope.

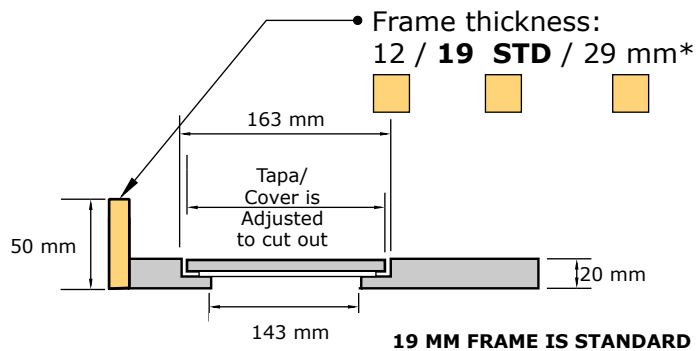

*) If glass wall: 29 mm frame
*) Check price list for cost of 29 mm frame

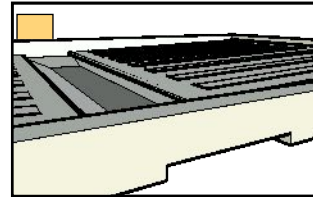

GROOVE FOR OVERFLOW WATER

Indicate position on drawing +

length:
Width:
Depth:

*) Spor på underside for overløpsvann kan stressse materialet når dette blir for tynt ved slik utskjæring. Vær Obs på god støtte og evt forsterkninger med riktig limbruk ved installasjon.

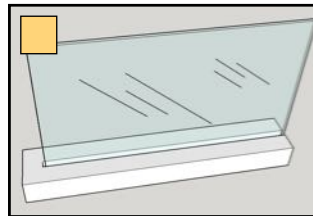

GROOVE FOR GLASS WALL

Indicate position on drawing +

length:
Width:
Depth:

Check price list for cost

POSITION & SIZE OF THE CUT OUT C & D = Center Point of drain hole

SIZE OF CUT OUT: (Ex: 80X500 mm)

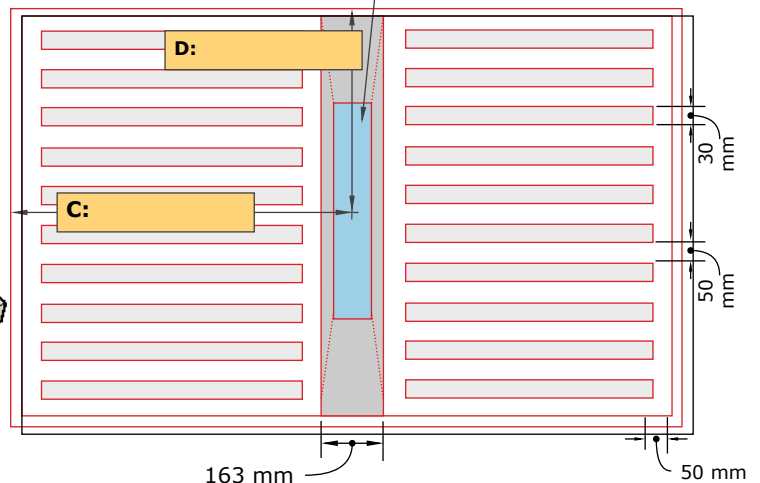

MAX SIZE: 1200 X B: 3000 MM
HEIGHT FRAME: 50 MM
FRAME THICKNESS*): 11mm / 19mm / 29mm
*) Mark on drawing if you different thickness on any of the sides.

Position of the cut out has to be located within given measurements.

Tapa / Cover over drain area will be adjusted manually on the factory to fit the cut out.

B Lengde:

A: Dybde

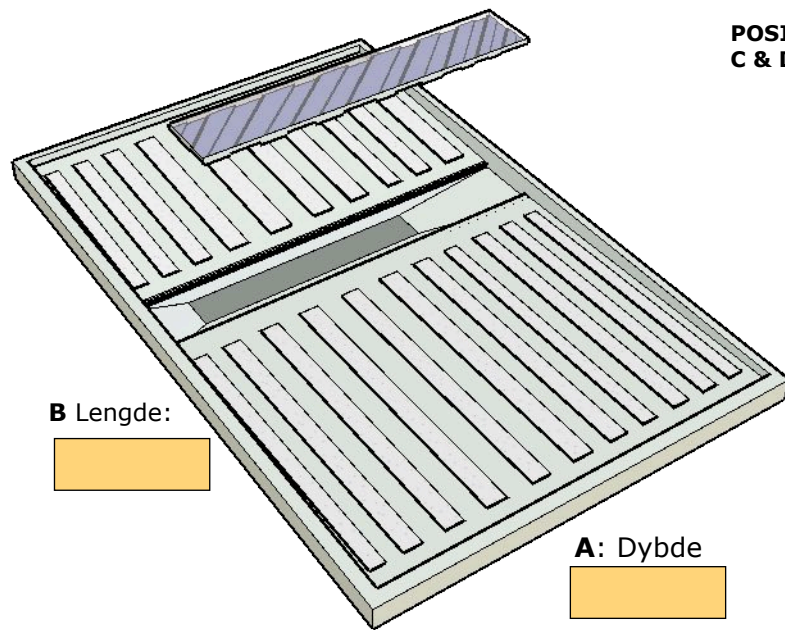

EXTRA BACK WALL

12 mm Silestone

YES

NO

COLOR:

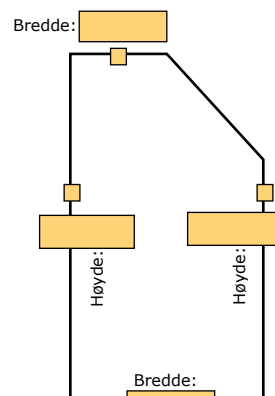
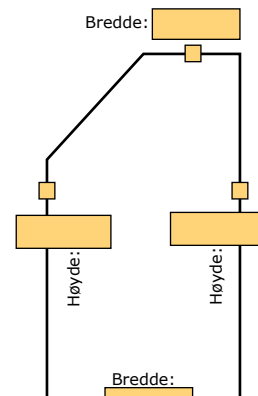
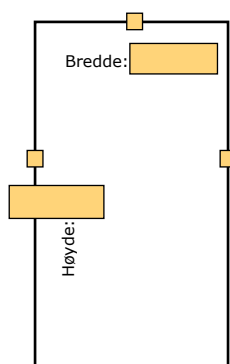
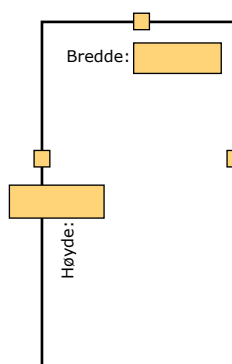
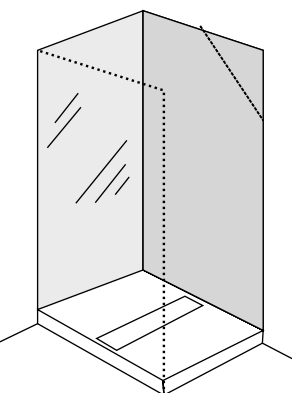

= Check Box for edge polishing